





HAWIDO - REGULATING VALVES

Instruction manual for

**Dirt trap
type 2002**

DN40 to DN200



Store this instruction manual near the location of the product!

Example of rating plate

Artikel Nr./Type of Valve:	2002 080 000		hawido
Serie-Nr./Serial No.:	12345	DN 80	PN/ND 10/16
Sieb/Sieve: 2054 - 0,6mm	TS max.40°C	Baujahr/Year:	01/2021

INHALTSVERZEICHNIS

A. FUNCTION	2
1. PRINCIPLE OF OPERATION	2
2. GENERAL SAFETY INSTRUCTIONS	2
3. RECOMMENDED INSTALLATION	3
4. DIMENSION TABLE	4
B. MAINTENANCE AND REPLACEMENT PARTS	5
1. MAINTENANCE AND SERVICE	5
1.1 GENERAL INFORMATION	5
1.2 DIRT TRAP DN 40 BIS DN 200 (DRAWING)	5
1.3 DIRT TRAP (PARTS LIST)	6
1.4 TORQUES	6
C. PRESSURE LOSS DIAGRAM	7
D. HAWLE IN EUROPE	8

A. Function

1. Principle of operation

A dirt trap stops any floating particles in the drinking water getting through. This significantly reduces any functional disturbances in the downstream Hawido regulating valve. The filter screen built into the housing must be periodically checked for dirt and cleaned if necessary.

Technical features:

Medium:	Drinking water
Pressure levels:	PN 10 – PN40
Flanges:	Connection dimensions according to DIN EN 1092 - 2
Overall length according to DIN:	EN-558
Housing/cover material in- and outside	EN-GJS-400-15,epoxy powder-coated
Filter screen material;	stainless steel
Temperature range:	2 – 40°C
Cuff width filter screen	0.6 mm (standard), 2.0 mm and 5.0 mm (irrigation)

2. General safety instructions

These instructions must be read through carefully and understood before starting the commissioning. Damage to property and injuries to persons could occur as a result of improper installation, commissioning, operation and maintenance.

The dirt trap is designed for use in the drinking water supply. Other application media only after consultation with the manufacturer.

The technical regulations (e.g. SVGW, ÖVGW, DVGW...) and codes of practice (e.g. VDE, VDI ...), laws and standards are taken as a minimum standard, and must be adhered to and applied.

In principle, the designer, installation company or the operator is responsible for the layout, installation position, installation and commissioning of the fittings in the pipe. Design or installation errors can adversely affect the safe operation of the dirt trap, and can represent a significant risk. Please consult us in case of doubt.

3. Recommended installation

Before installing the fitting, the pipe lines must be carefully flushed through to prevent any foreign material, such as pieces of wood, stones etc., from entering the dirt trap.

To ensure the smooth functioning and maintenance of the dirt trap, we recommend installing it horizontally level whenever possible. It can also be installed vertically. However, when the water flows from the bottom to the top, the screen may not stop the floating particles from getting through.

Observe the installation direction of the dirt trap. There is an arrow on the housing.



Direction of

A shut-off valve must be installed before and after the dirt trap when the filter screen is to be serviced or cleaned, if it has not already been designed with a Hawido regulating valve.

4. Dimension table

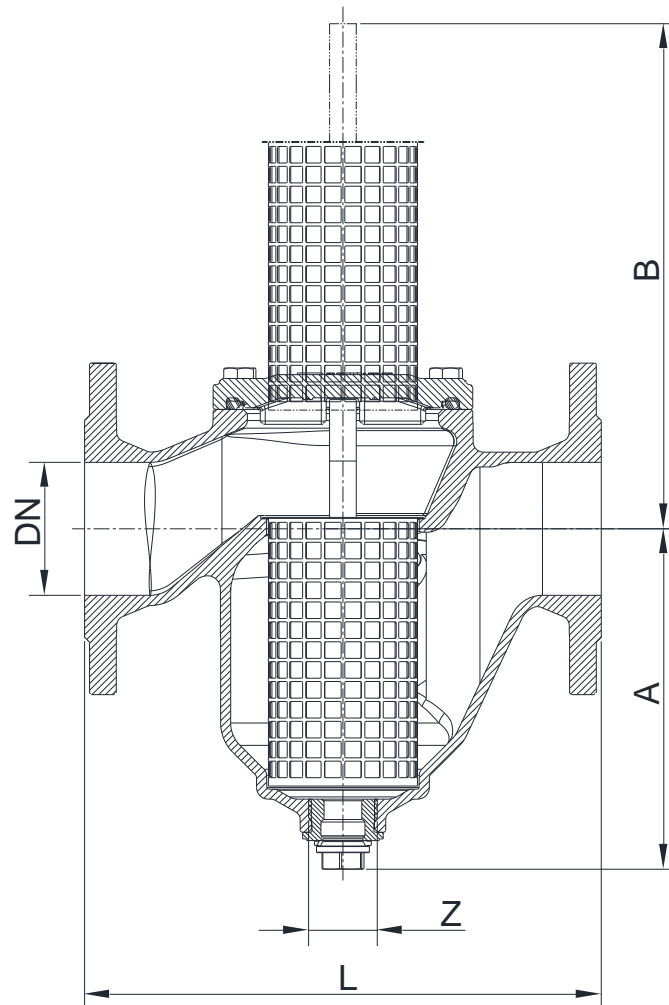

Article number	DN	PN	L	A	B	Z	Weight [kg]
2002 040 000	40	10 - 40	200	160	220	1/2"	9
2002 050 000	50	10 - 40	230	162	225	3/4"	12.6
2002 065 000	65	10 / 16	290	203	275	3/4"	17
2002 067 000	65	25 / 40	290	203	275	3/4"	17
2002 080 000	80	10 - 40	310	206	300	3/4"	24.5
2002 100 000	100	10 / 16	350	228	355	3/4"	27
2002 102 000	100	25 / 40	350	228	355	3/4"	29.5
2002 125 000	125	10 / 16	400	277	455	3/4"	38.3
2002 127 000	125	25 / 40	400	277	455	3/4"	39.6
2002 150 000	150	10 / 16	480	326	535	3/4"	54.4
2002 152 000	150	25 / 40	480	326	535	3/4"	55.7
2002 200 000	200	10	600	397	697	3/4"	109.2
2002 201 000	200	16	600	397	697	3/4"	109.2
2002 202 000	200	25	600	397	697	3/4"	111

B. Maintenance and replacement parts

1. Maintenance and service

1.1 General information

Under normal operating conditions, the dirt trap should be cleaned once a year.

Under exceptional operating conditions (e.g. high levels of floating particles in the water), it must be serviced more often.

Caution: The filter sieve (3) must be installed as shown (bracket across the direction of flow)!

1.2 Dirt trap DN 40 bis DN 200 (Drawing)

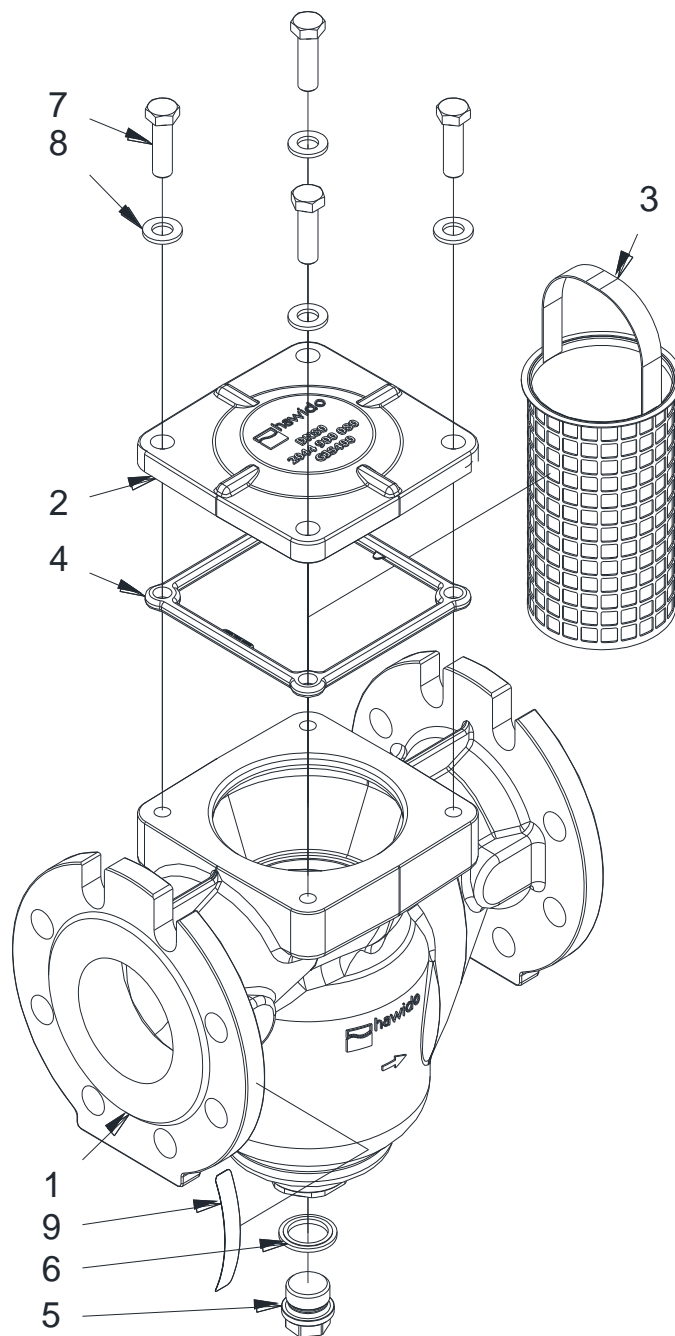

1.3 Dirt trap (parts list)

Item	Description	Material	Article number			
			DN 40	DN 50	DN 65	DN 80
1	Dirt trap complete PN10/16		2002 040 000	2002 050 000	2002 065 000	2002 080 000
	Dirt trap complete PN25/40		2002 040 000	2002 050 000	2002 067 000	2002 080 000
2	Cover	EN-GJS-400-15	2044 800 040	2044 800 050	2044 800 065	2044 800 080
3	Screen – cuff width 0.6mm	Stainless steel	2054 040 000	2054 050 000	2054 065 000	2054 080 000
	Screen – cuff width 2mm	Stainless steel	2054 040 020	2054 050 020	2054 065 020	2054 080 020
	Screen – cuff width 5mm	Stainless steel	2054 040 050	2054 050 050	2054 065 050	2054 080 050
4	Cover seal	EPDM	2094 040 000	2094 050 000	2094 065 000	2094 080 000
5	Lock screw	Stainless steel	0511 016 002	0511 025 002	0511 025 002	0511 025 002
6	Compound seal	Stainless steel NBR	0130 016 000	0130 025 000	0130 025 000	0130 025 000
7	Hexagonal screw M12 x 40	Stainless steel	0006 612 040	0006 612 040	0006 612 040	0006 612 040
8	U-washer M12	Stainless steel	0008 212 000	0008 212 000	0008 212 000	0008 212 000
9	Rating plate					

Item	Description	Material	Article number			
			DN 100	DN 125	DN 150	DN 200
1	Dirt trap complete PN10		2002 100 000	2002 125 000	2002 150 000	2002 200 000
	Dirt trap complete PN16		2002 100 000	2002 125 000	2002 150 000	2002 201 000
	Dirt trap complete PN25		2002 102 000	2002 127 000	2002 152 000	2002 202 000
	Dirt trap complete PN40		2002 102 000	2002 127 000	2002 152 000	-
2	Cover	EN-GJS-400-15	2044 800 100	2044 800 125	2044 800 150	2044 800 200
3	Screen – cuff width 0.6mm	INOX	2054 100 000	2054 125 000	2054 150 000	2054 200 000
	Screen – cuff width 2mm	INOX	2054 100 020	2054 125 020	2054 150 020	2054 200 020
	Screen – cuff width 5mm	INOX	2054 100 050	2054 125 050	2054 150 050	2054 200 050
4	Cover seal	EPDM	2094 100 000	2094 125 000	2094 150 000	2094 200 000
5	Lock screw	INOX	0511 025 002	0511 025 002	0511 025 002	0511 025 002
6	Compound seal	INOX / NBR	0130 025 000	0130 025 000	0130 025 000	0130 025 000
7	Hexagonal screw M12 x 40	INOX	0006 612 040	0006 612 040	0006 612 040	0006 612 040
8	U-washer M12	INOX	0008 212 000	0008 212 000	0008 212 000	0008 212 000
9	Rating plate					

1.4 Torques

The tightening torque of the cover screws is 55 Nm for all dimensions.

C. Pressure loss diagram

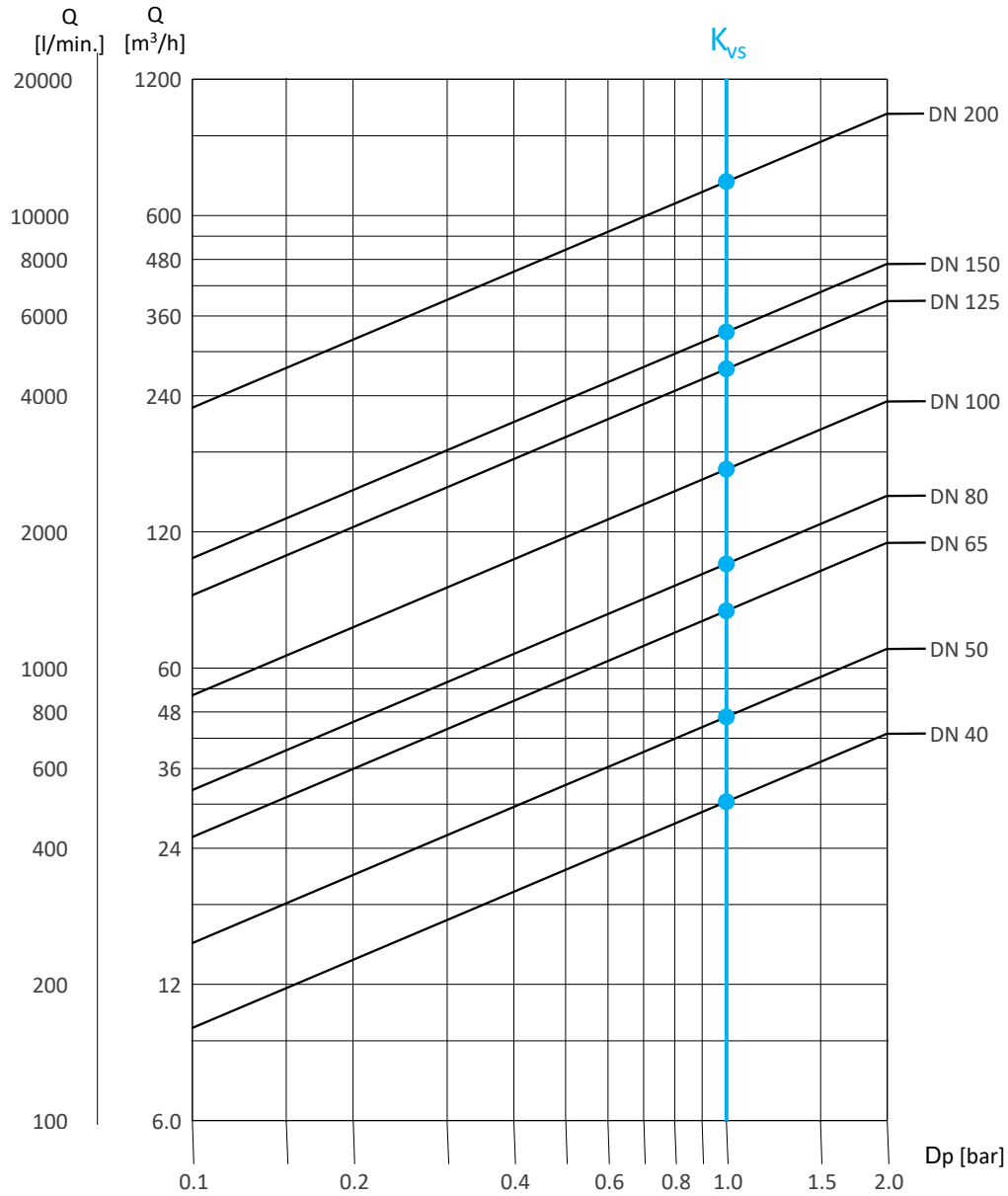

DN	Kvs	
	m³/h	l/min.
40	31	506
50	47	780
65	81	1339
80	102	1700
100	165	2750
125	275	4584
150	332	5534
200	713	11883

D. Hawle in Europe

Adressen:

Hawle Armaturen AG
Hawlestrasse 1
CH-8370 Sirnach
www.hawle.ch

Telefon +41 (0)71 969 44 22
Telefax +41 (0)71 969 44 11

Hawle Armaturen GmbH
Liegnitzer Strasse 6
D-83395 Freilassing
www.hawle.de

Telefon +49 (0)8654 63 03 - 0
Telefax +49 (0)8654 63 03 60

E. Hawle Armaturenwerke GmbH
Wagrainerstr. 13
A-4840 Vöcklabruck
www.hawle.at

Telefon +43 (0)76 72/72 576 0
Telefax +43 (0)76 72 78 464

Hawle Kft
Dobogókői út 5
H-2000 Szentendre
www.hawle.hu

Telefon +36 (0) 26 501 501
Telefax +36 (0) 26 501 502

Hawle Armatury spol. s r.o.
Ricanská 375
CZ-25242 Jesenice u.Prahy
www.hawle.cz

Telefon +420 (0)2 410 03 111
Telefax +420 (0)2 41 00 33 33

Hawle Spółka zo.o
ul. Piaskowa 9
PL-62-028 Kozięglowy
www.hawle.pl

Telefon +48 (0)61 811 14 00
Telefax +48 (0)61 811 14 27

Hawle s.r.o.
Pezinská c.30
SK-903 01 Senec
www.hawle.sk

Telefon +421 (0)2 45 92 21 87
Telefax +421 (0)2 45 92 21 88

S.C. Hawle S.R.L.
Calea Sagalui 104
RO-300516 Timisoara
www.hawle.ro

Telefon +40 268 47 78 81
Telefax +40 356 80 06 68

DM Armaturen EOOD
Ul. Lokomotiv 3
BG-1220 Sofia
www.hawle.bg

Telefon +359 (0)2 931 12 77
Telefax +359 (0)2 931 04 36

Partner / Kontaktadresse:

18.02.2021-1

